

# Mikron NRG-50

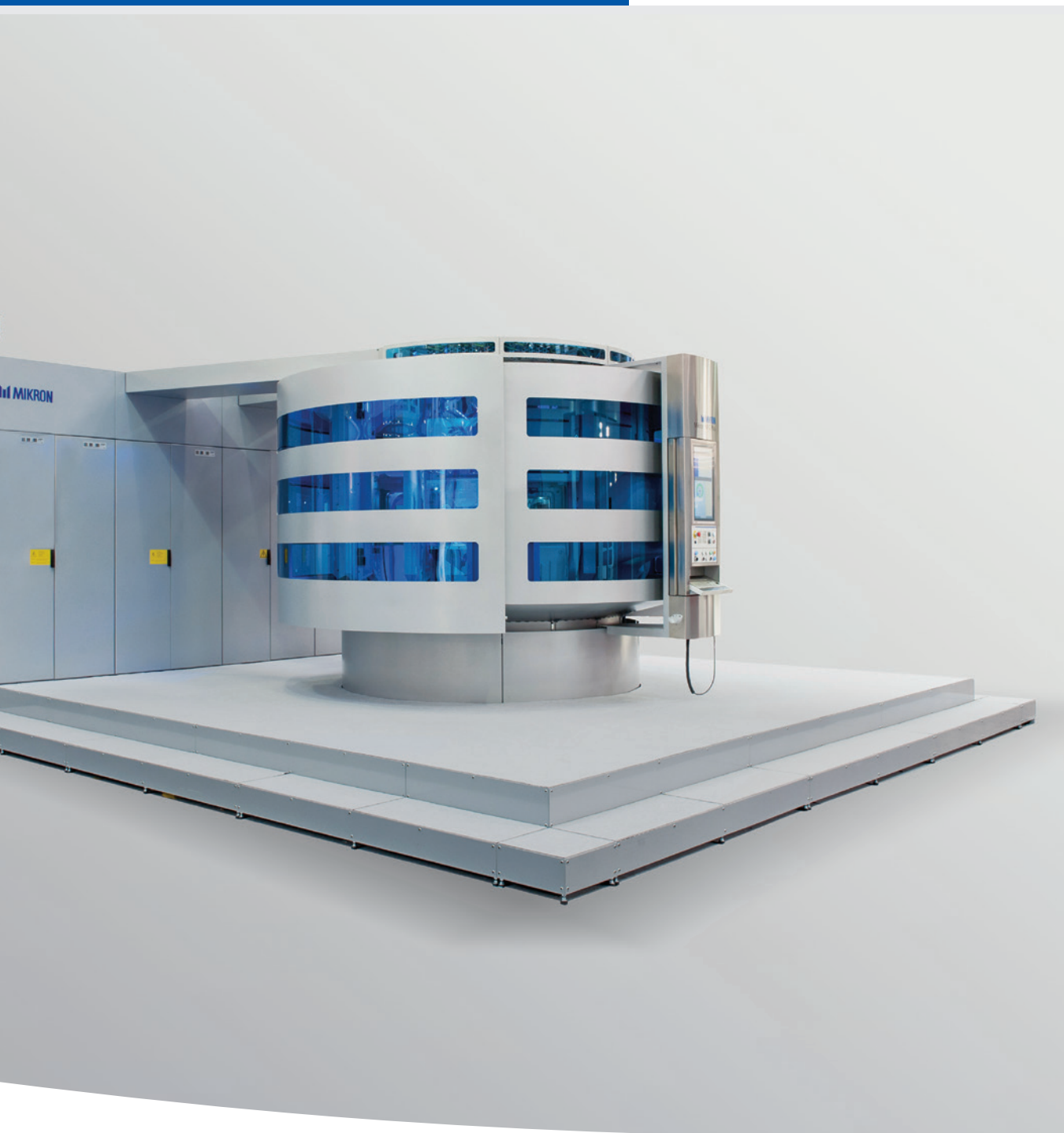

The response to your  
tomorrow's needs

# Mikron NRG-50: The Concept of the Future

## The New Generation of Transfer Machines

Due to rapid technical developments, the speed of innovation is constantly increasing. The results are more complex parts, faster product advances and smaller series. The new transfer machine developed by Mikron clearly takes these changed parameters into consideration. The completely modular built Mikron NRG-50 offers the customer an optimal balance of productivity, high flexibility and investment costs.

**The future-oriented concept of the Mikron NRG-50** makes it possible completely to machine work pieces up to 50x50x50 mm or cylindrical pieces up to Ø35x70 mm with 12 stations. Mikron NRG-50 finishes steel, non-ferrous metals or aluminum from wire, from rod or from blanks. Synchronized modular components allow maximal machining ability, from highly productive to highly flexible. The Mikron NRG-50 is a transfer machine with great flexibility for a broad spectrum of application, in which Mikron's know-how has a full effect, from A to Z.

### The Advantages of Mikron NRG-50

#### Precision

- ATS (Advanced Thermal Stabilization): All elements of the machine are thermally stable
- "IndraMotion MTX" from Bosch Rexroth: A modern and highly innovative control technique
- Index mechanism of the turntable is close to the machining axis
- CNC-machining units
  - Very rigid and extremely compact construction
  - Spindle bearing with minimal overhang

#### Productivity

- Machine configuration
  - Up to 3 machining units on a single station
  - Up to 30 units in production simultaneously
- Minimal down-times
  - Table rotation and index time less than 1 second
  - Fully automatic tool changer (ATC), chip-to-chip time 2.5 seconds
- Highest machining speed
  - Spindles up to 40,000 min<sup>-1</sup>
  - High acceleration values and traversing rate of the machining units
  - Use of complex and efficient cutting tools from Mikron Tool

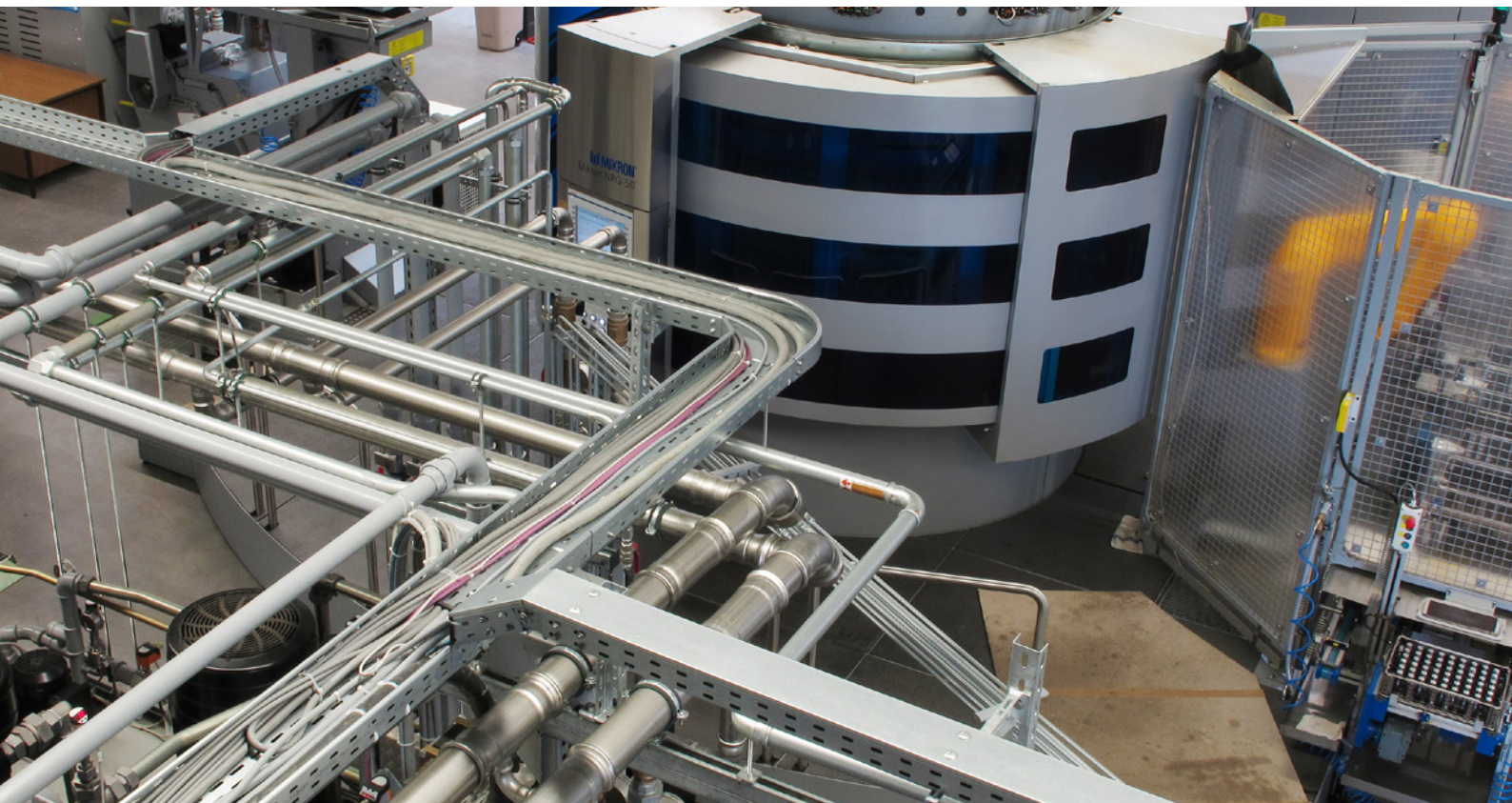

## Mikron NRG-50 with Horizontal Table

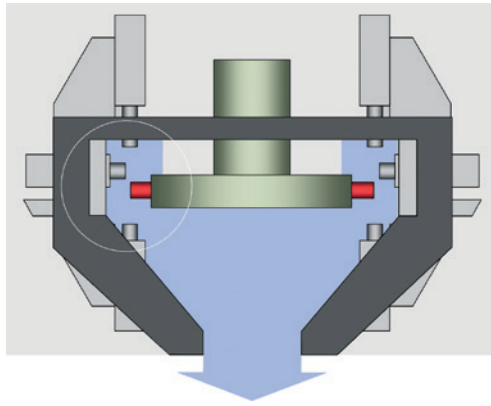

- Turntable with **horizontal** work piece clamping
- Units outside of the machining area
- Machining area: Cooling and removal of chips with cutting oil
- Acclimatized area free of chips and oil mist

- Efficiency and reliability
  - Simple clamping and unclamping of tool holder
  - HMI: Advanced diagnostic and scheduled maintenance
  - High reliability: Motors, kinetic and cables in acclimatized and clean outer area
  - Efficient evacuation of chips into central machine basin

### Flexibility

- Modular concept
  - Perfect configuration for individual machining tasks
  - Simple adaptation to changing production requirements
- Up to 96 tools on one machine available
- 6-surface machining possible
- Variety of work piece-clamping concepts and spindles
- External 5-axis robot
  - Loading and unloading of work pieces
  - Automatic exchange of work piece-clamping systems

### Variety of Machining

- Various machining processes
  - Drilling, deep-hole drilling, reaming, turning, milling, thread cutting, recessing
  - Complex path and contour milling with CNC controlled clamping device
  - All machining can be done in inclined position
- Various procedures
  - Turning with two opposite units (high concentricity)
  - Milling or drilling on one station with three units simultaneously
- CNC-Axes
  - Up to four axes interpolation per spindle
  - Fifth CNC-axis for tilt unit (C-axis)
  - Additional U-axis for recess turning
  - CNC-controlled work piece clamping devices (B-axis)

## Precision

# ATS: Advanced Thermal Stabilization New and one-of-a-kind for Highest Precision







ATS is a new concept developed by Mikron for the all-inclusive regulation of machine temperature. A cooling lubricant or circulating air cools all elements exposed to temperature changes. Heat regulators provide the optimal temperature for both cooling media. The released heat can be economically reused. The entire machine is an enclosed, thermally stable system that is independent from exterior influences and heat generated during production.

### Mikron NRG-50: The only transfer machine with ATS.

ATS guarantees

- Highest machine base-precision: Due to consistent adjustment of motor and machining heat
- Short warm-up time: The machine is put into operation quickly, since operating temperature is achieved in minimal time
- High operational reliability: All rotating drives function within optimal temperature conditions
- No precision variations during interruption of production.

### ATS: Advanced Thermal Stabilization

	Temperature regulation of the machine body
	Cooling of the spindle motors
	Cooling of the main motor
	Air-cooling of the cabin
	Air-cooling of the electric cabinets
	Heat exchanger

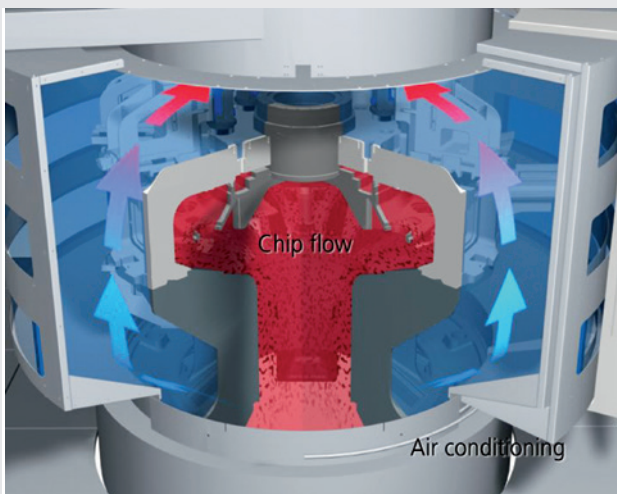

Machine room:  
acclimatized

Machining area:  
temperature controlled  
with cooled cutting oil

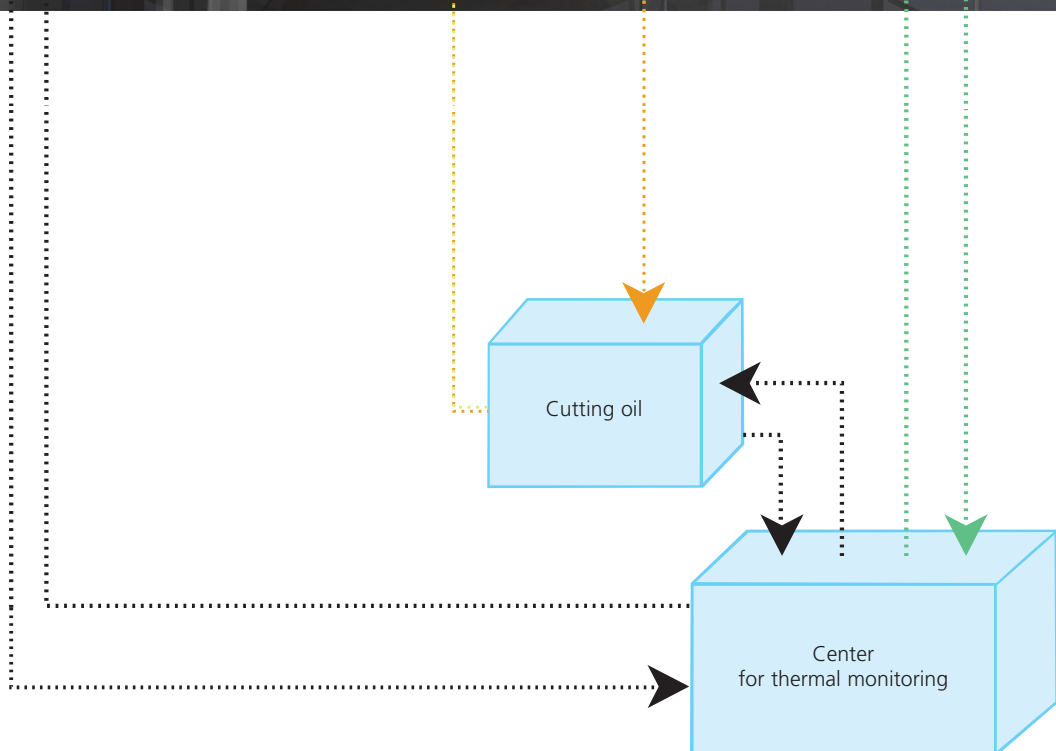
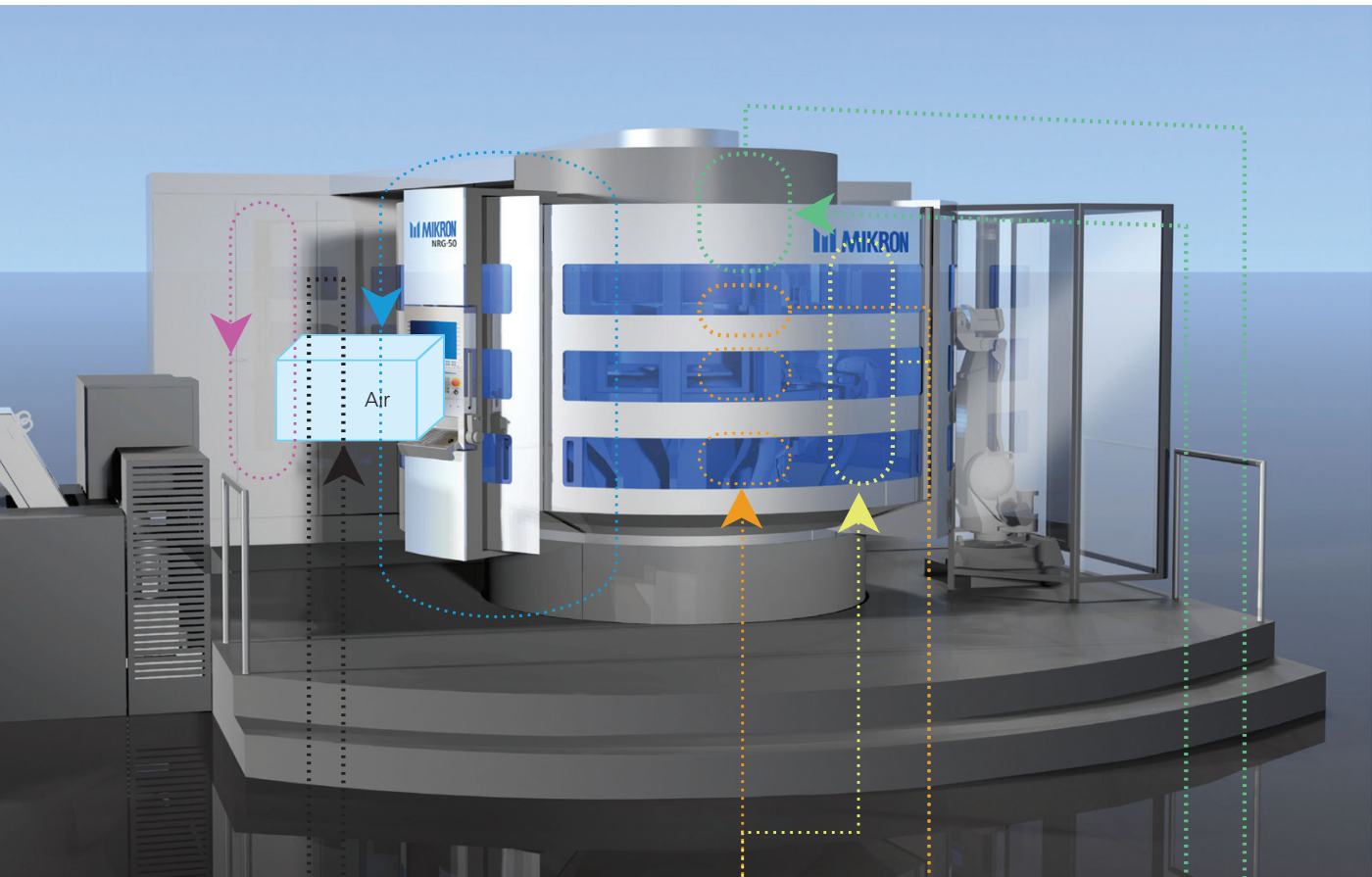

## Productivity

# Mikron NRG-50: Capable for High Performance in Every Aspect

The perfectly balanced modular concept of the Mikron NRG-50 makes it possible to apply **three machining units on one station**: up, down and externally horizontal.

All three units can machine the work piece simultaneously, thereby achieving the closest position tolerances. The one-of-a-kind combination of multiple machining on one station guarantees high precision and at the same time high productivity. A maximum of **30 simultaneously working units can be employed on 12 stations**.

- High number of processes in one pass
- Complete machining of the most complex work pieces in one clamping
- Machining of 6 surfaces is possible when utilizing CNC work piece clamping devices.

Additional performance features:

- Table rotation and index time less than 1 second
- Fully automatic tool changer ATC, change-out time 2.5 seconds
- High performance spindles up to 40,000 min<sup>-1</sup>

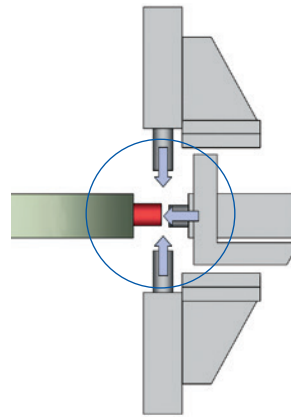

Simultaneous application of three machining units.

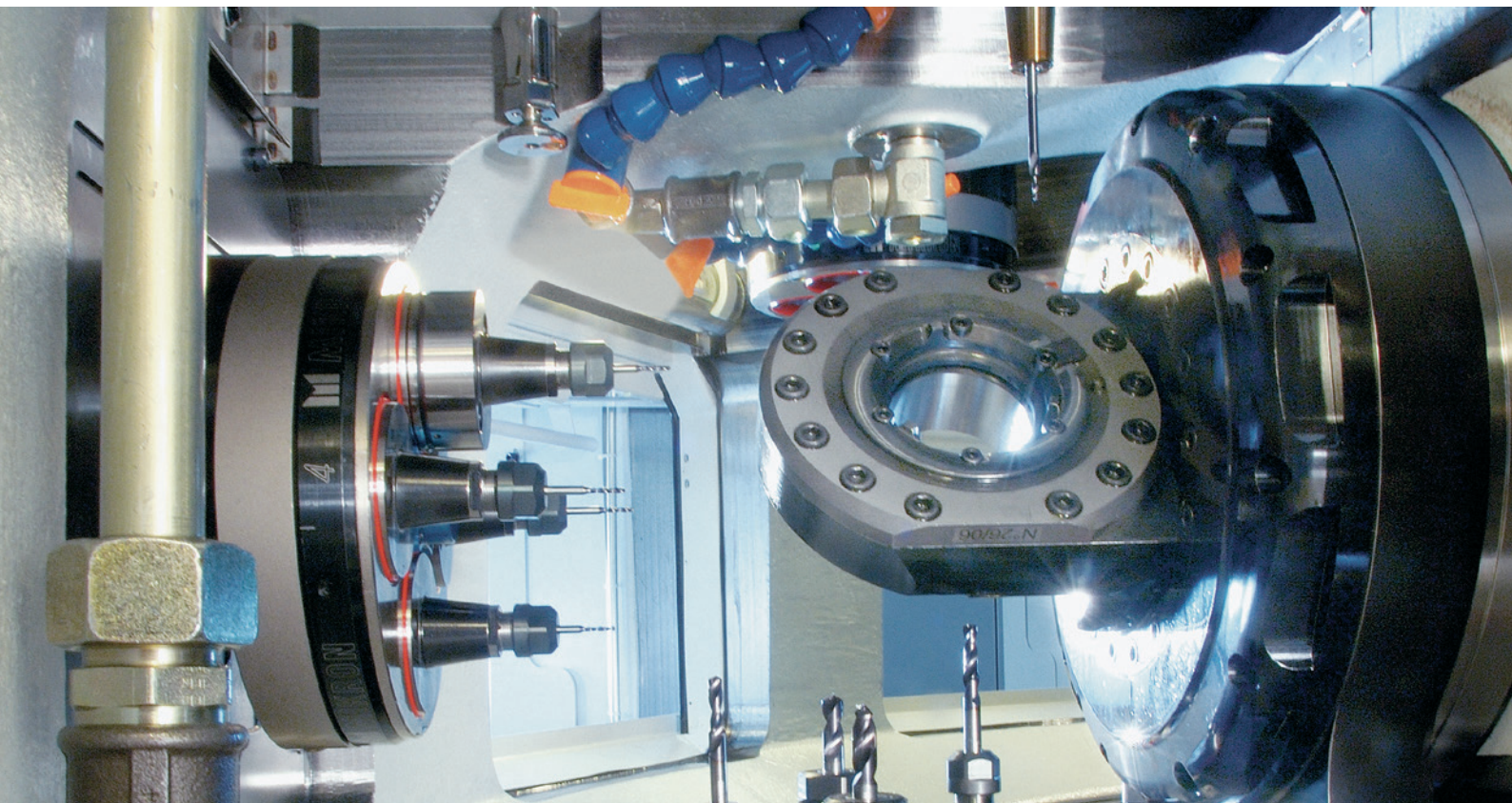

**High reliability:**  
Motors, kinetic and all  
cables are outside of  
machining area.

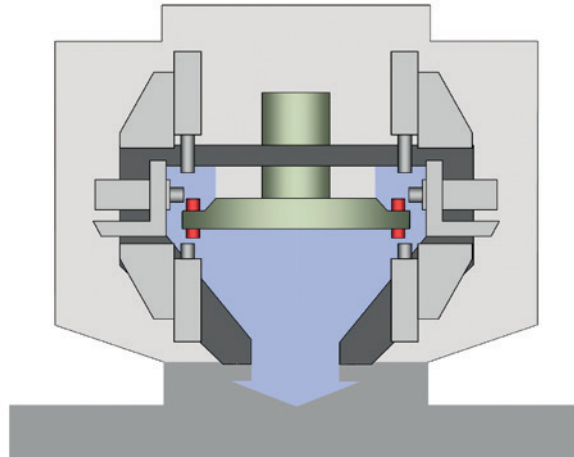

#### The numerical control

Mikron NRG-50 is equipped with the newest control generation **"IndraMotion MTX"** from Bosch Rexroth. Due to the application of this sophisticated CNC control technique, it is possible to reduce down times significantly.

- Simple operation and programming due to user friendly and multi lingual menu guides. The operator is supported in diagnostic, production data management and 3D simulation by a simple and concise screen display.
- Diagnostic: Problems can be identified and analyzed by using remote diagnostic. Corrections are made fast and efficiently via modem.
- Simple program operation for complex work pieces up to 140 CNC axes.



#### Easy tool exchange

Simple clamping and unclamping of the tool holder with hydraulic operation:

- High machine availability and productivity due to fast tool exchange
- Convenience and safety for the operator.



## Flexibility

# Mikron NRG-50: Adaptable to all Needs

The modular concept of the Mikron NRG-50 makes it possible to configure the installation for individual machining tasks. The adaptation to changing production requirements is simple and practical.

- Upper and lower units are identical and can be exchanged or replaced with each other at any time
- Units with three, two or one CNC-axis can be selected depending on degree of flexibility
- All units can be combined with a multitude of spindles
- The basic precision of the machine body allows for a simple and fast exchange of units.

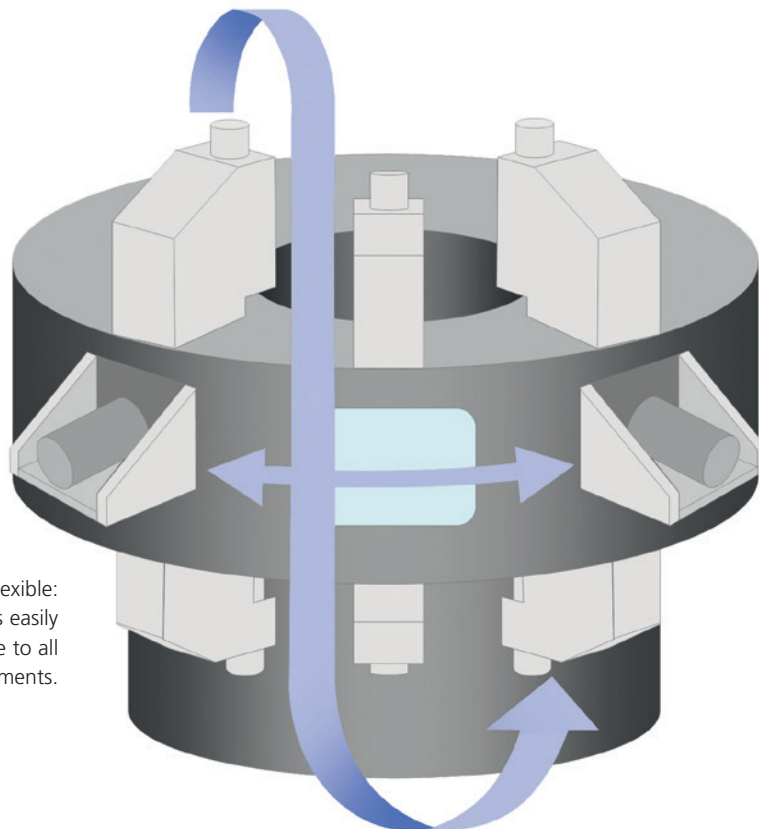

Very flexible:  
Mikron NRG-50 is easily  
and quickly adaptable to all  
production requirements.



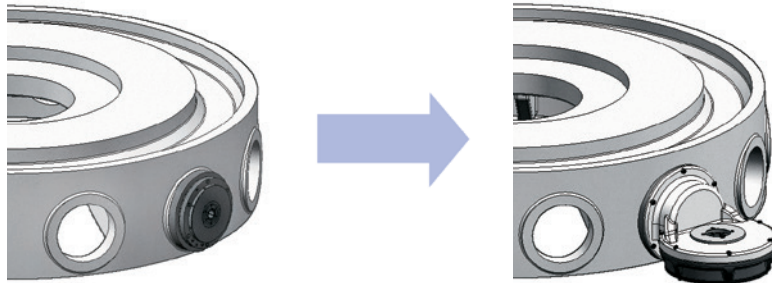

Conversion from horizontal to vertical work piece clamping.

#### Various workpiece clamping systems

Especially rigid and precise Mikron collets, ideal for work pieces up to a diameter of 35 mm and a max. length of 70 mm.

- For round and individually shaped parts with precise outer contour.

Hydraulic or mechanical clamping devices, ideal for universal application: cast, forged and pre-machined parts of a maximum of 50 mm in linear length.

- The closing pressure is adjustable for each machining operation in order to guarantee a form stability for unstable work pieces.

Work piece carrier palettes with standardized interface provide for a simple and fast exchange of different clamping devices or work pieces. An electronic coding for the palette identification is possible.

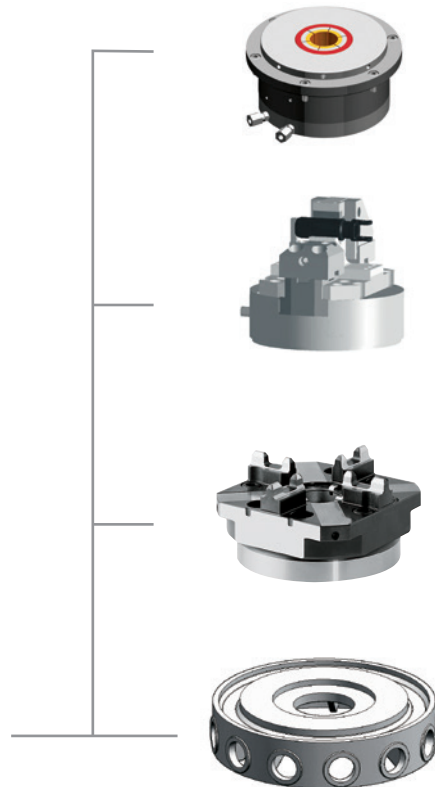
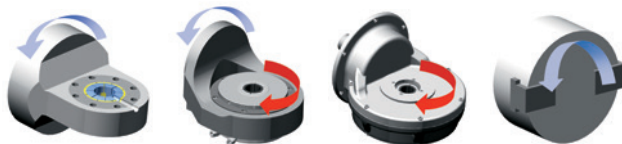

#### Additional clamping systems

for the conversion from horizontal to vertical work piece clamping.

## Flexibility

# Mikron NRG-50: Adaptable to all Needs

### Automatic 4-way tool changer (ATC)

Mikron NRG-50 is the only transfer machine that can be equipped with up to **22 tool changers**. If equipped to capacity, the Mikron NRG-50 carries **a total of 96 tools**. The large number of tools provides for maximum flexibility.

- Due to 96 tools even highly demanding parts can be produced
- Different machining processes, like centering, drilling, thread cutting, milling and turning are possible on one station
- Optimal cycle time: Synchronizing of unequal machining times (caused by machining, such as deep-hole drilling or milling) with several different machining processes at one station
- Reduction of machine set-up time for the change-over to different work pieces
- Higher operational availability: Exchange of several equal cutting tools during machining with high wear increase the operational autonomy.

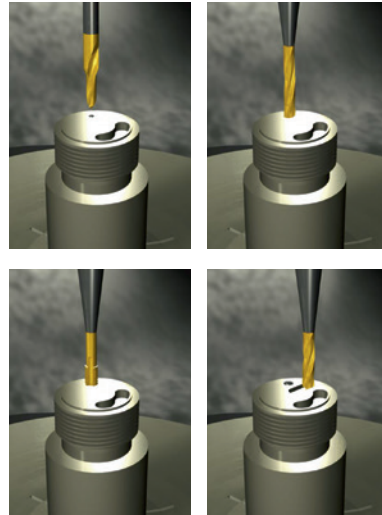

Different machining processes with the automatic tool changer (ATC) from Mikron NRG-50.

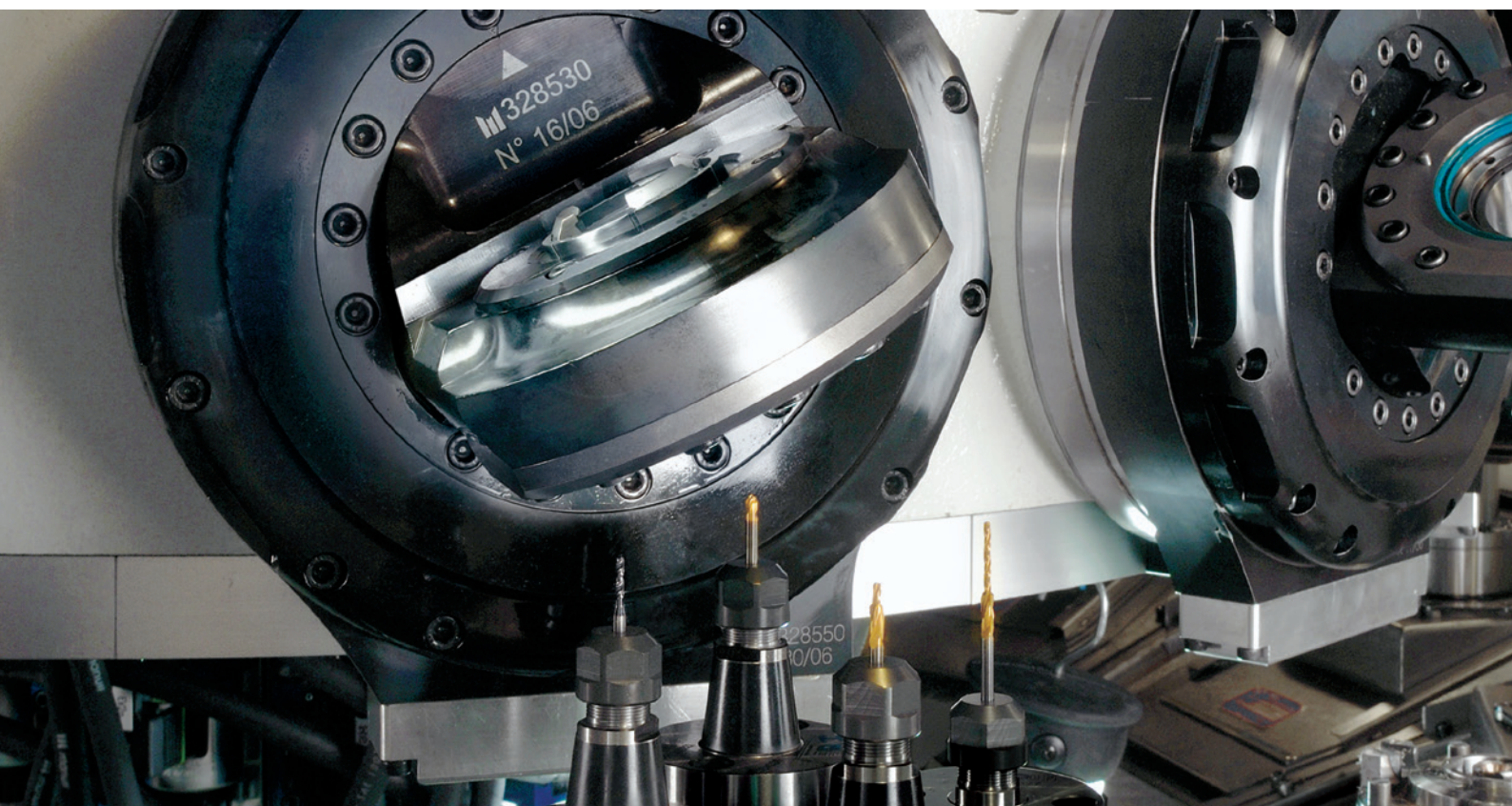

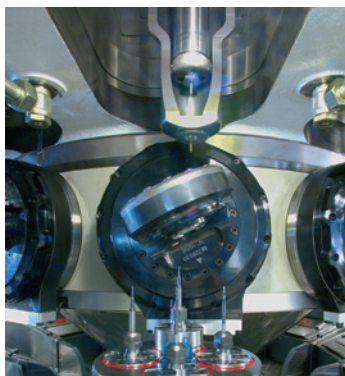

DEEP Spindle, ideal for deep-hole drilling.

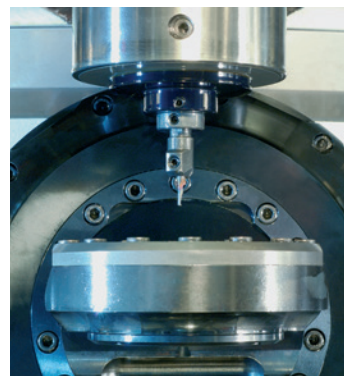

RH Spindle, ideal for precise recessing.



#### **ST Spindle (Standard)**

Oil cooled spindle with HSK 40-A and internal cooling supply up to 80 bar for normal machining.



#### **HP Spindle (High Performance)**

Oil cooled spindle with HSK 40-A and internal cooling supply up to 80 bar, spindle with high capacity, also suitable for thread cutting.



#### **HS Spindle (High Speed)**

Oil cooled spindle with HSK 32-E and internal cooling supply up to 80 bar for HSC machining.



#### **DEEP Spindle**

Spindle for deep-hole drilling with internal cooling supply up to 200 bar.

#### **RH Spindle (Recess Head)**

Spindle with internal cooling supply for interior boring, ideal for precise recessing and contour turning.

#### **ATC Spindle (Automatic Tool Changer)**

Four-way tool changer (chip-to-chip time 2.5 seconds), also suitable for thread cutting, with HSK 40-F and internal cooling supply up to 80 bar.

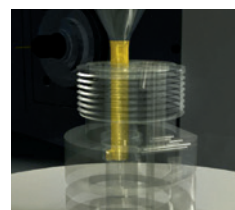
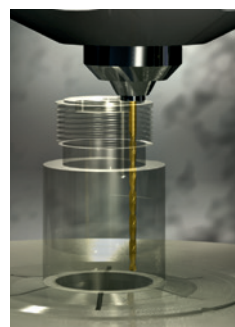

## Versatility

# Mikron NRG-50: The All-Rounder

The greatest variety of operations can be performed depending on machine configuration: From simple machining processes such as drilling, to complex milling operations with 4-axes interpolation. The versatility of the Mikron NRG-50 permits a broad combination of machining possibilities.

- Complete machining of a work piece – turning, milling, drilling – without premachining on other machines
- Simultaneous turning with opposing units – above and below – on one station (for highest concentricity)
- Additional operations as deburring, high pressure flush, broaching or simple assembling is also possible
- Measuring operations and measurement corrections in interaction with the CNC control can be integrated into the machining process
- Machining of up to 6 surfaces possible.

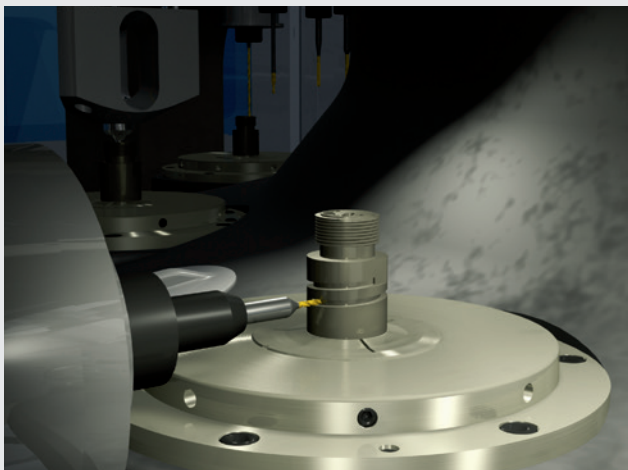
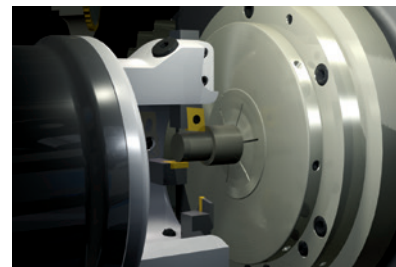
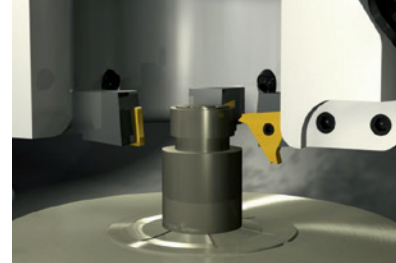

Complex path and contour milling with CNC controlled clamping device.

Workpiece tilting device for 5 axis machining (of which up to four simultaneously).

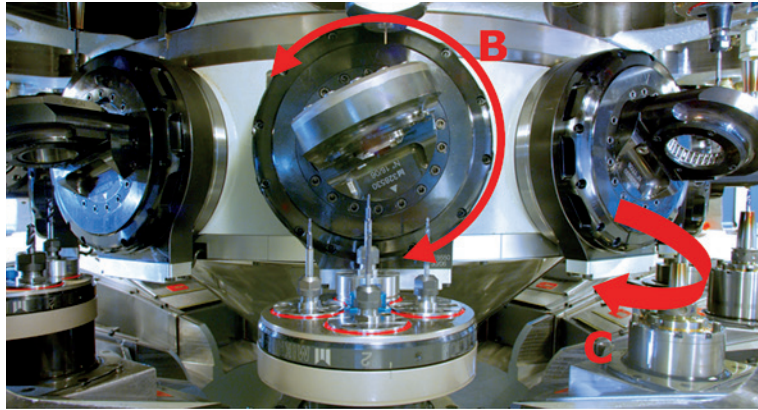

#### The ideal solution for complex operations

The separately controllable tilt unit makes angularly aligned machining possible. Utilizing the CNC controlled clamping device makes it possible to machine various surfaces of the work piece in any position.

- No geometrical limitations
- Recess turning also possible in tilted position
- Unlimited possibilities of a multitude of machining possibilities in various positions.

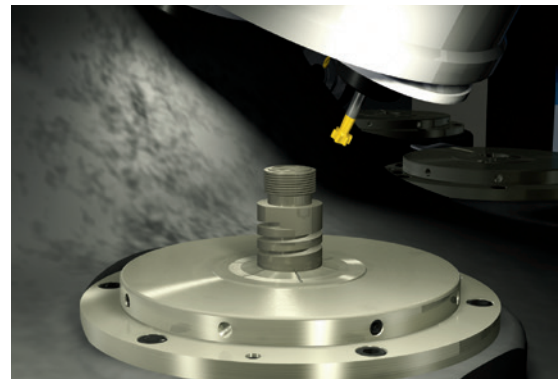

#### Adjustable collet carrier (CNC-controlled)

Adjustable work piece clamping devices enable machining in all positions.

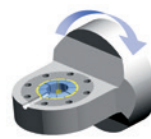

Fixed collet

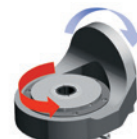

Rotating / indexing collet



# Mikron Service Solutions

Flexible and modular

We ensure quick, competent and uncomplicated service and support for our customers. We work together with you to design a service solution profile tailored to your individual needs.



REACTIVE

## Technical Support – repair your machine

- Helpdesk
- Remote Diagnostics
- Augmented Connection
- Service Assignment



PROACTIVE

## Business Support – keep & improve machine productivity

- Process Monitoring (OEE Improvement)
- Training
- Energy Consumption
- New Applications & Simulations
- Engineering
- Interactive Troubleshooting
- Startup & Production Support
- Service Level Agreements



PREVENTIVE

## Service & Maintenance – prevent machine stops

- Technical Evaluation
- Preventive Maintenance
- Spindles & Groups Overhaul
- Extended Warranty
- Software Backups



SPARE PARTS

## Spare Parts – reliable supply of original Mikron spare parts

- Original Mikron spare parts
- Xchange Modules



PREDICTIVE

## miS4.0 – predict your machine maintenance

- Production Monitoring
- Condition Monitoring
- Failure Analysis
- Mikron cloud and IoT platform (SAP Leonardo)



SECOND LIFE

## 2<sup>nd</sup> life – guarantee continuous use of your investment

- Machine Overhaul
- Retooling
- Safety & Environments
- Updates & Upgrades
- Retrofitting

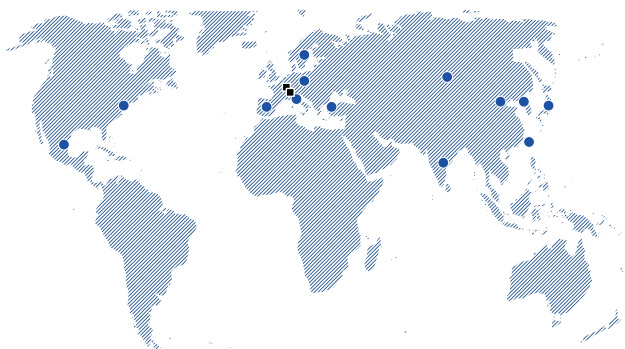

Contact your Service Center today, we gladly be of assistance.

- **Production sites**  
Switzerland, Agno; Germany, Rottweil
- **Strategic partnership or presence**

Switzerland  
**Service Center**  
Tel. +41 91 610 61 61  
service.mag@mikron.com  
OH: 08.00 - 17.30

Germany  
**Service Center**  
Tel. +49 741 5380 200  
service.mro@mikron.com  
OH: 08.00 - 17.30

USA/Canada  
**Service Center**  
Tel. +1 203 261 31 00  
service.mmo@mikron.com  
OH: 7.30 am - 5.00 pm EST

China  
**Service Center**  
Tel. +86 1592 1577 050  
services.mm.msh@mikron.com  
OH: 08.00 - 17.30

## Mikron Machining

### **Mikron Switzerland AG, Agno Division Machining**

Headquarter  
Via Ginnasio 17  
6982 Agno  
Switzerland  
Tel. +41 91 610 61 11  
Fax +41 91 610 66 80  
mag@mikron.com

### **Mikron GmbH Rottweil** Berner

Feld 71  
D-78628 Rottweil  
Tel. +49 741 5380 0  
Fax +49 741 5380 580  
mro@mikron.com

### **Mikron Corp. Monroe**

200 Main Street  
P.O. Box 268  
Monroe, CT 06468 / USA  
Tel. +1 203 261 31 00  
Fax +1 203 268 47 52  
mmo@mikron.com

